

TOP VIEW  
SCALE: 1"=1'-0"

2'-8"  
(813 mm)

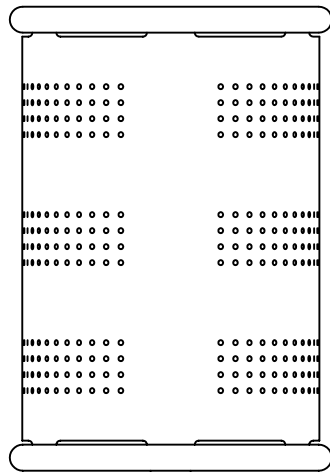

0'-0"  
FINISHED GRADE

FRONT VIEW  
SCALE: 1"=1'-0"

INCLUDES 18-GALLON RECYCLED PLASTIC LINER.  
SEE DETAILS AT RIGHT FOR INDIVIDUAL MODELS.

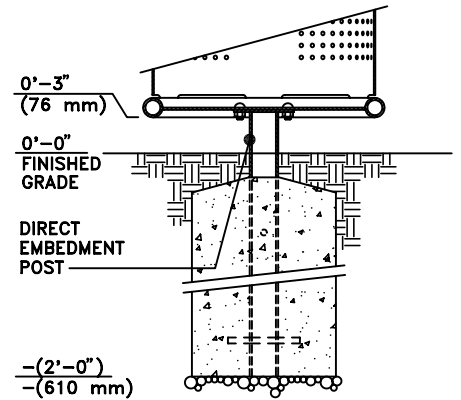

NOTE:  
CONCRETE FOOTING AND NO. 4 REBAR (BY OTHERS) PER LOCAL SOIL CONDITIONS. CONSULT PROJECT ENGINEER FOR EXACT REQUIREMENTS.

2615-FT-E (EMBEDMENT)  
SCALE: 3/4"=1'-0"

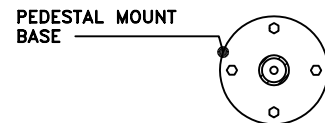

5/8" (16 mm) DIA. HOLES PROVIDED FOR ANCHORS BY OTHERS (TYPICAL-4)

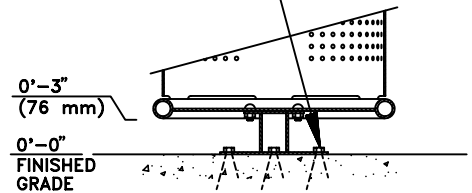

2615-FT-P (PEDESTAL MOUNT)  
SCALE: 3/4"=1'-0"

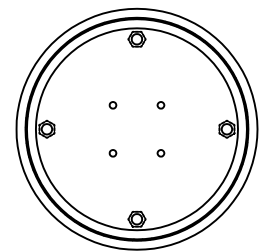

LEVELING FOOT (TYPICAL-4)

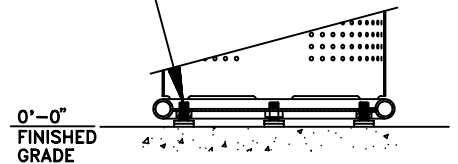

2615-FT-L (LEVELING MOUNT)  
SCALE: 3/4"=1'-0"

This drawing reveals the copyrighted intellectual property of Columbia Cascade Company. Not for use by others without our express, written authorization.

Authorization for use is hereby granted to architects, landscape architects and similar design professionals solely for the purpose of specifying TimberForm products.



COLUMBIA CASCADE COMPANY

Makers of TimberForm®, PipeLine®, RePlay®, TimberForm®-2, InterPlay®, CycLoops® and CycLocker® Products.

1300 S.W. Sixth Avenue, Suite 310 Telephone 503/223-1157  
Portland, Oregon 97201-3464 Facsimile 503/223-4530  
U.S.A.

WWW.TIMBERFORM.COM

Title:  
TIMBERFORM BOULEVARD  
MODEL NO. 2615-FT  
LITTER CONTAINER,  
WITH FLAT TOP



Scale NOTED  
Drawn by: AT 07-04-10  
Ck'd by:

Drawing No.  
W-2615-FT

Sheet  
1 of 1